

CONNECTIONS	
INLET	3/4" BSP.
OUTLET	3/4" BSP.
DRAIN	14 mm OD. HOSE TAIL
OVERFLOW	14 mm OD. HOSE TAIL

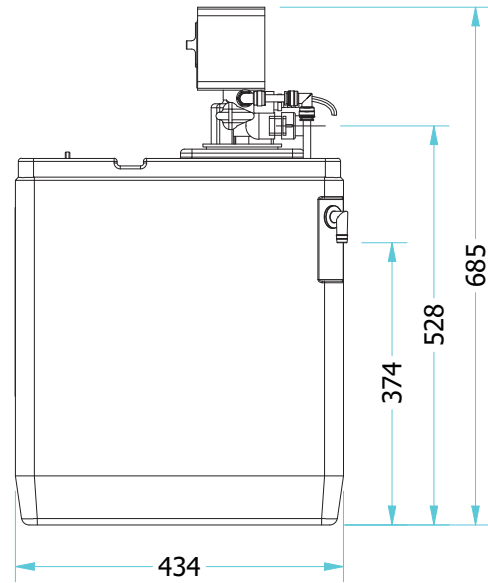

HOT WATER SOFTENER INSTALLATION REQUIREMENTS	
WATER PRESSURE	MIMIMUM 1.5 BAR / MAXIMUM 3 BAR.
WATER TEMPERATURE	MAXIMUM 60 DEG CELSIUS - PROTECT FROM FREEZING.
ELECTRICAL SUPPLY	24/240 V VAC3 AMP MAINTAINED POWER SUPPLY
CAPACITY	2929 LTRS (@ 286 PPM HARDNESS)

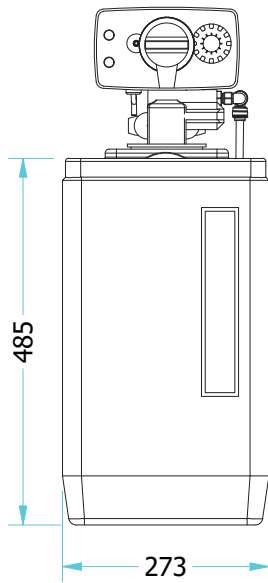

EUROPEAN WATERCARE LTD  
REGAL HOUSE, SOUTH ROAD  
HARLOW, CM20 2BL  
ESSEX, ENGLAND  
TEL: +44 (0) 1279 780 250

EUROPEAN WATERCARE LTD  
This drawing and its contents are the exclusive property of European Watercare Ltd and may not be used, copied or disclosed to any third party without the express written permission of European Watercare Ltd. It must be returned immediately upon request.

APPR. BY:  
APPR. DATE:  
SCALE: 1:10  
JOB No:  
DRAWN BY: RM  
DATE: 11/01/2020  
SHEET SIZE: A4

REV. | P |



TITLE:  
PH18 - 18 LTR HOT WATER SOFTENER  
EUROPEAN WATERCARE

SHEET NUMBER: 1 OF 1

DRAWING No. PH18